

PLAY with a Purpose

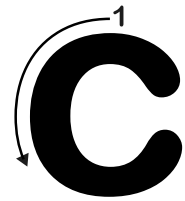

Handwriting practice lines consisting of four sets of horizontal lines. Each set includes a solid top line, a dashed middle line, and a solid bottom line.

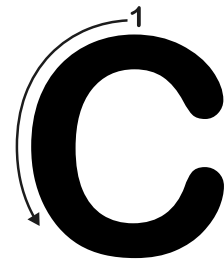
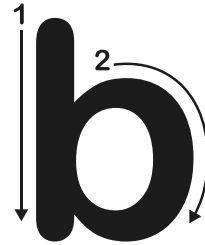
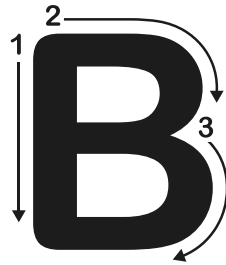
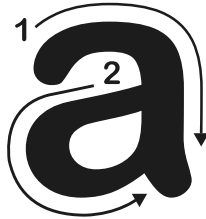
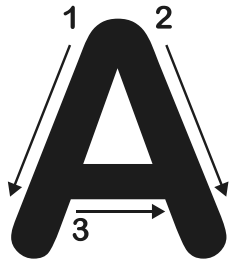
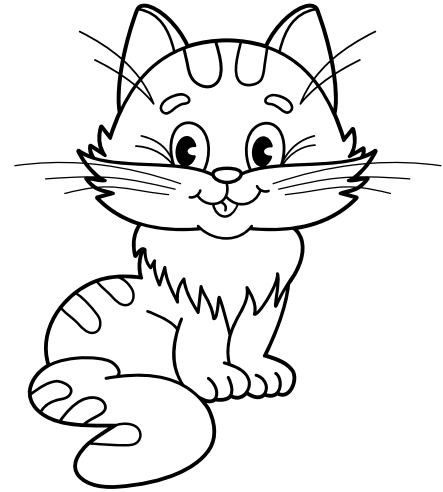
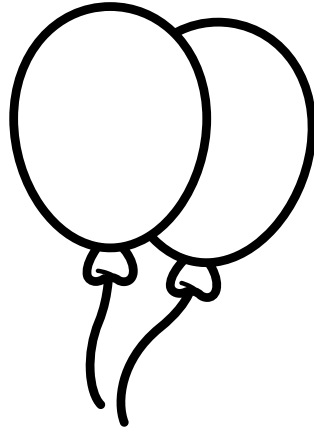
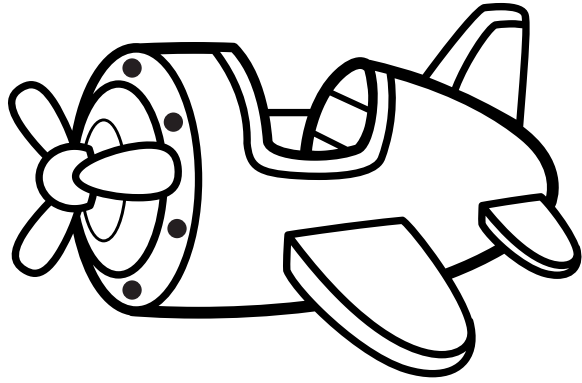
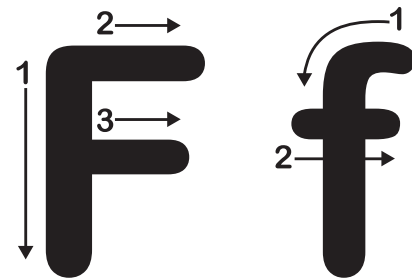
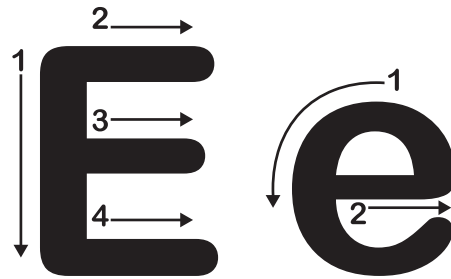
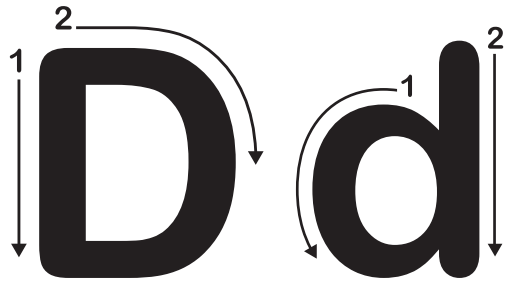
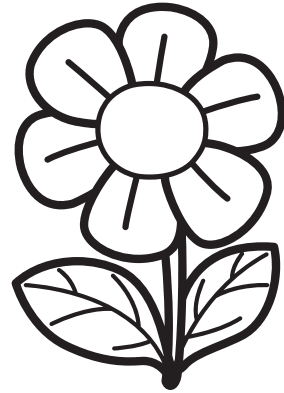
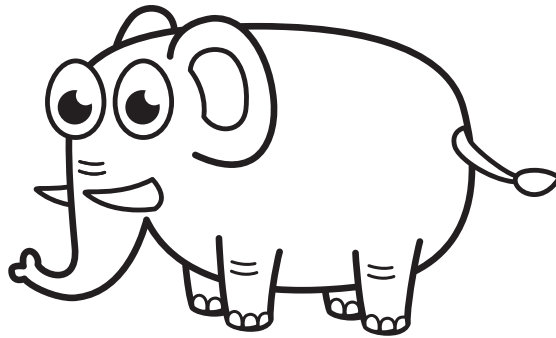
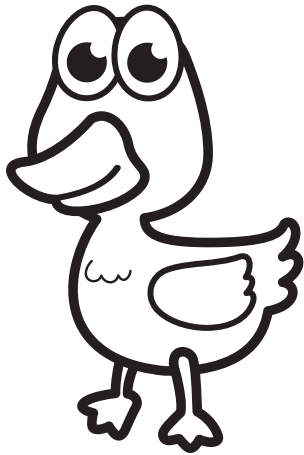

Handwriting practice lines consisting of four sets of three horizontal lines: a solid top line, a dashed middle line, and a solid bottom line.

PLAY with a Purpose

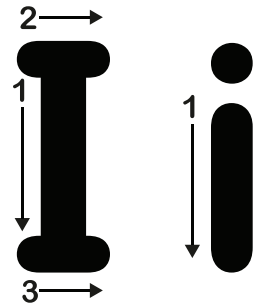
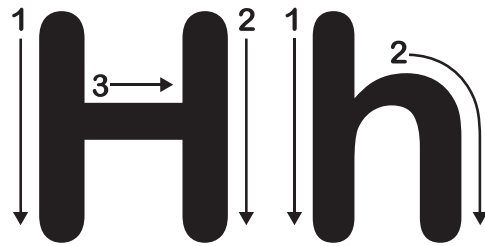
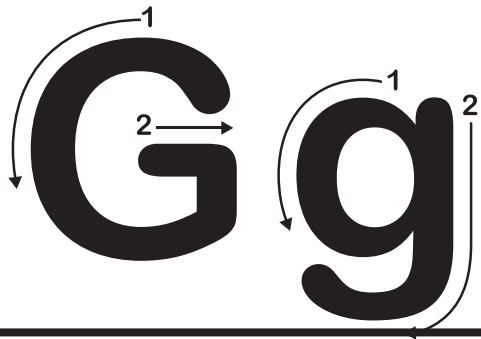
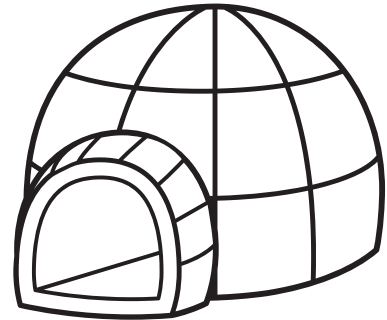
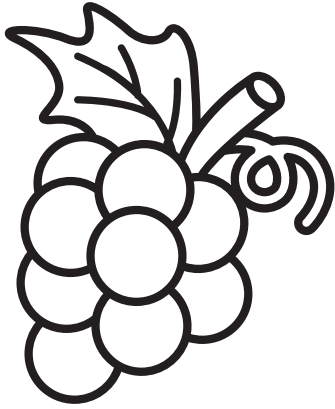

Handwriting practice lines consisting of a solid top line, a dashed middle line, and a solid bottom line, repeated twice.

PLAY with a Purpose

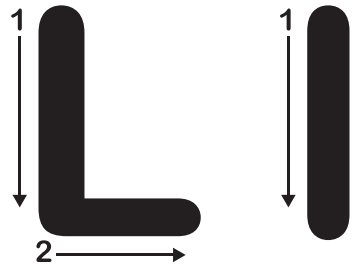
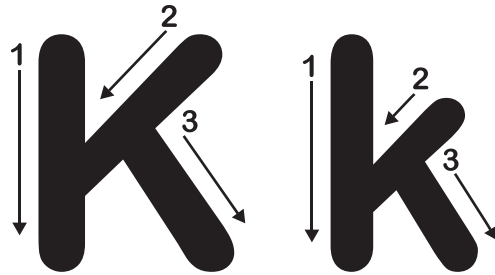
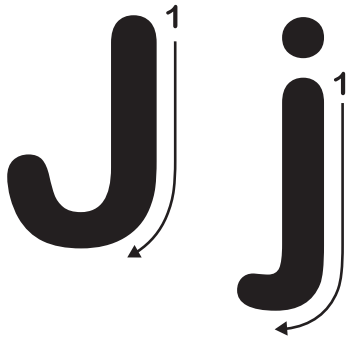
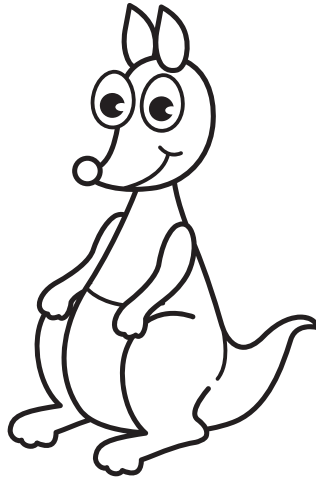
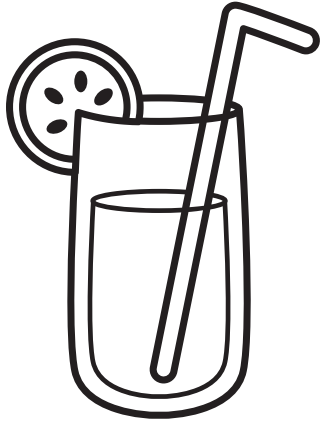

Handwriting practice lines consisting of two sets of three horizontal lines (top solid, middle dashed, bottom solid).

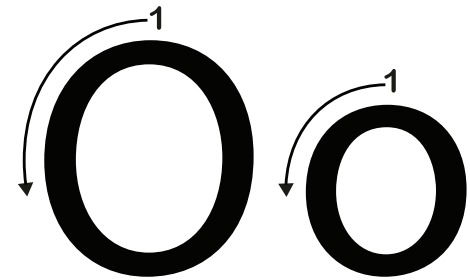
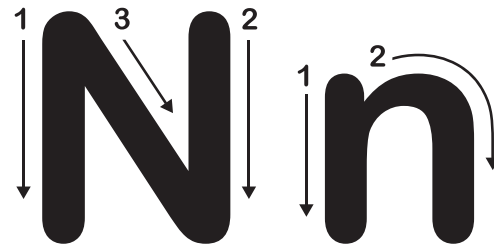
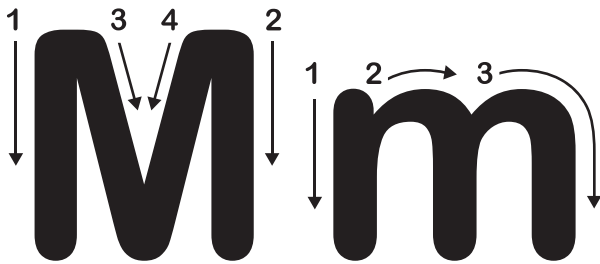
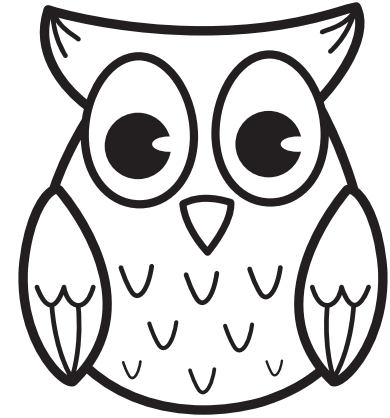
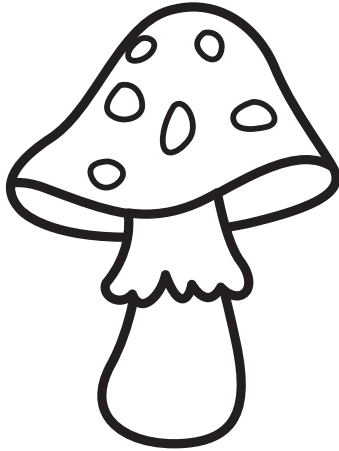

Handwriting practice lines consisting of two sets of three horizontal lines: a solid top line, a dashed middle line, and a solid bottom line.

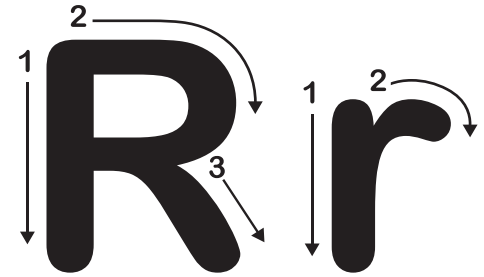
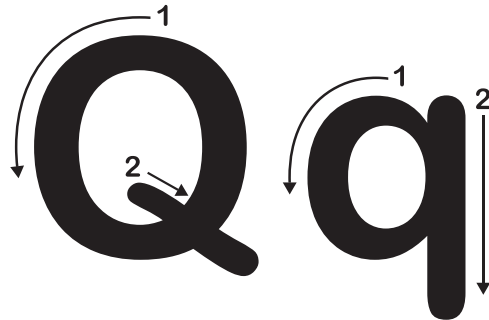
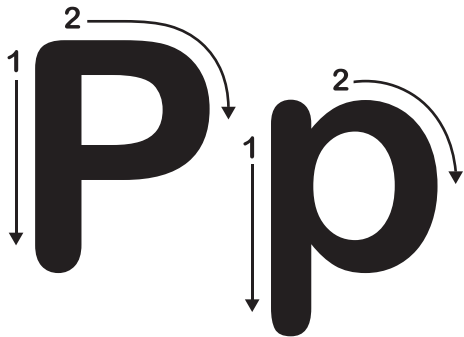
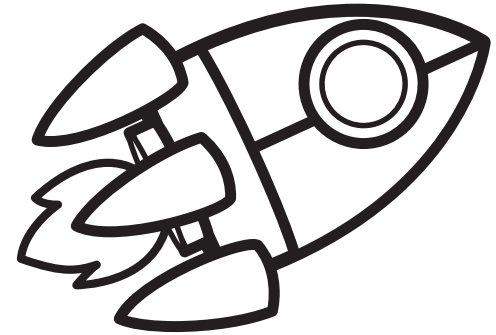
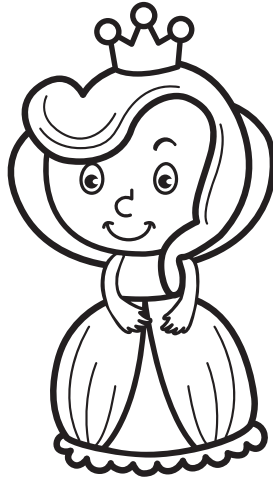
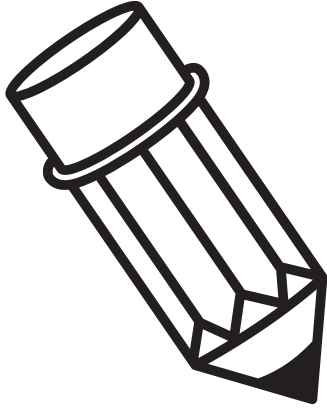

Handwriting practice lines consisting of two sets of three horizontal lines (top solid, middle dashed, bottom solid).



S s

T t

U u

Handwriting practice lines consisting of two sets of three horizontal lines: a solid top line, a dashed middle line, and a solid bottom line.

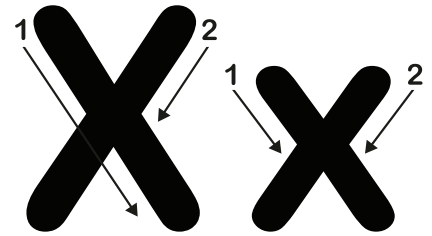
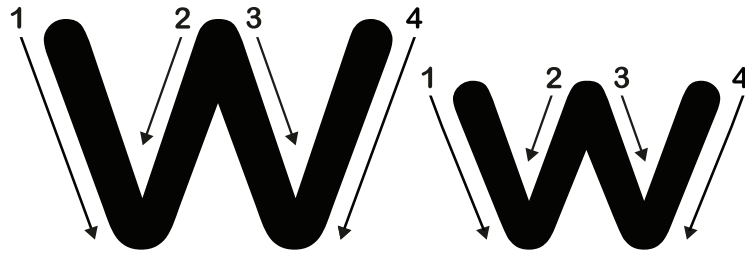
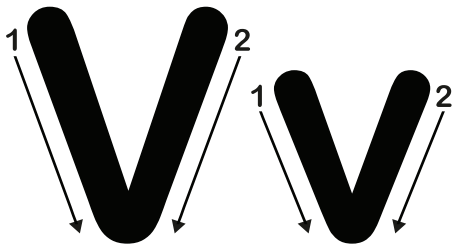
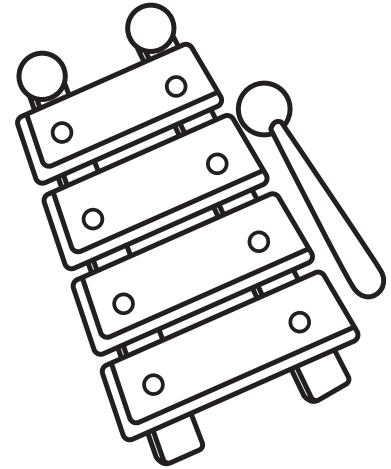
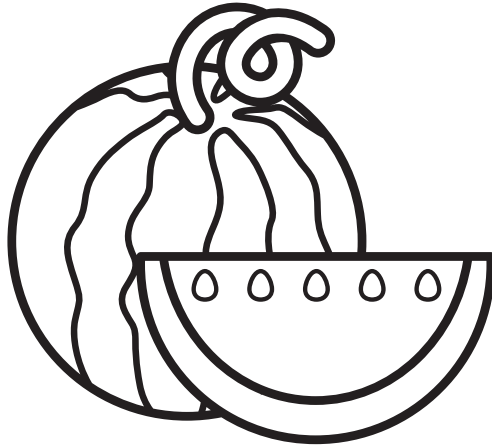

Handwriting practice lines consisting of four sets of horizontal lines. Each set includes a solid top line, a dashed middle line, and a solid bottom line, providing a guide for letter height and placement.



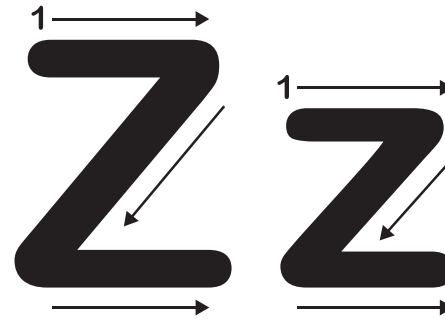
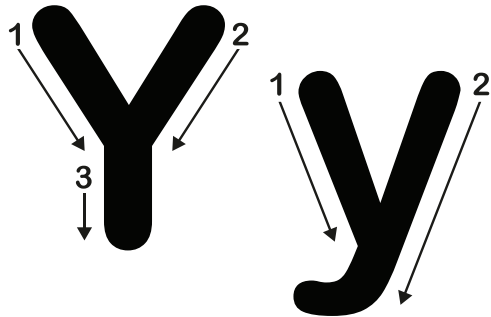
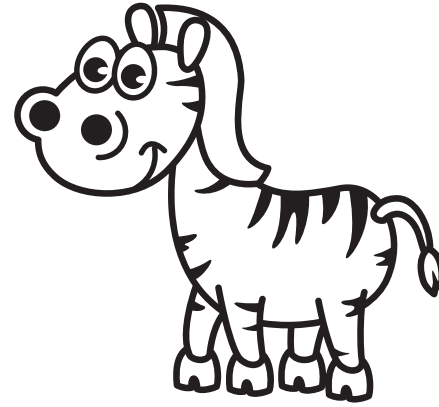
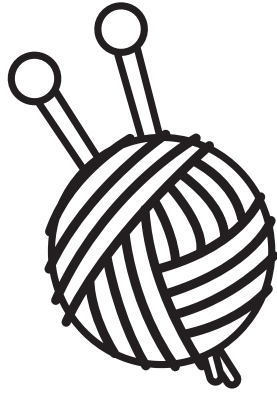

Handwriting practice lines consisting of two sets of three horizontal lines (top solid, middle dashed, bottom solid).